

mcmurdo

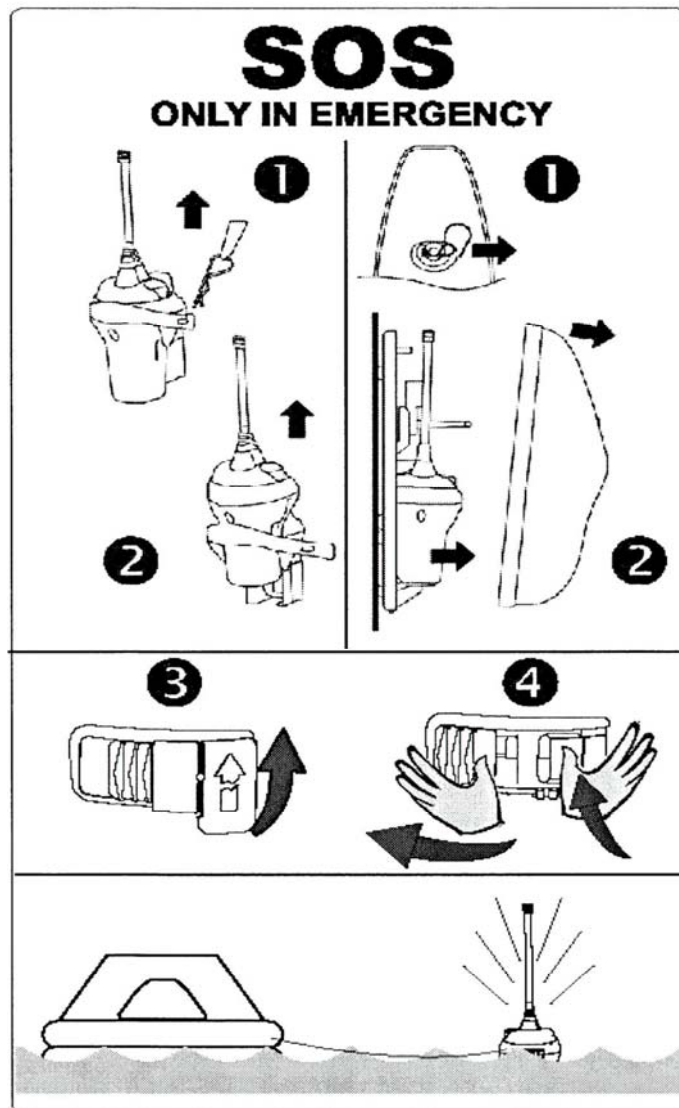

SMARTFIND
E5/G5
USER MANUAL

This manual is applicable to both the E5 Smartfind and the G5 Smartfind Plus EPIRBs. The Smartfind Plus contains a GPS receiver for improved positional accuracy; some parts of this manual are applicable only to the Smartfind Plus, and are marked accordingly.



APPLICATION

This EPIRB (Emergency Position Indicating Radio Beacon) is designed for use in maritime emergencies, and is approved for these contingencies.

It is not designed or recommended for use on land or in the air.

Use the EPIRB only in situations of grave and imminent danger. Intentional false alerts may result in penalties.

REGISTRATION

This EPIRB must be registered with the appropriate national authority.

The function of the EPIRB is to send an alert to the COSPAS-SARSAT satellites, as described in the Appendix. How soon an alert is received depends on the positions of the satellites at the time, and can be influenced by overhead obstructions aboard the vessel. Rescue time following an alert depends on the overall performance of the Search and Rescue organisations, which is outside the control of McMurdo.

IN EMERGENCY

Remove the EPIRB completely from its bracket or enclosure

Hold the lanyard spool and throw the EPIRB into the water where it will self-activate

OR

If time permits, pull the tear-off tab up, then press the activation button and slide the switch left

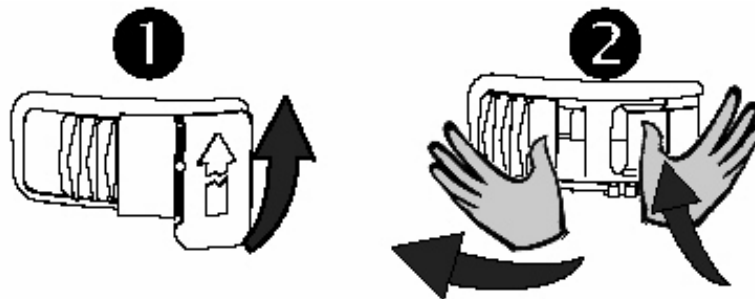

Contents

1	Recommendations and safety notices	2
2	Mandatory Registration	3
2.1	Overview	3
2.2	How to register	3
2.3	Warranty form	4
2.4	Radio licence	4
2.5	Sale or transfer	4
3	Description	6
3.1	Bulkhead bracket	8
3.2	Float-free enclosure	9
4	Controls	10
4.1	Activation switch	10
4.2	TEST button	10
4.3	Sea switch	10
4.4	LEDs	10
4.5	Buzzer	11
5	Operating procedure	12
5.1	Sinking	12
5.2	Abandon ship	12
5.3	GPS Operation (Smartfind Plus only)	12
5.4	Releasing EPIRB from a bulkhead bracket	15
5.5	Releasing EPIRB from an enclosure	16
5.6	Manual activation	16
5.7	Deactivation	17
5.8	Re-fitting EPIRB	17
6	False alerts	21
6.1	Stand down rescue services	21
6.2	Turn off the EPIRB	21
6.3	Dealing with a transmitting EPIRB	22
7	Fully disabling an EPIRB	23
8	Bulkhead bracket installation	24
8.1	Siting	24
8.2	Mounting procedure	24
9	Enclosure installation	26
9.1	Siting	26
9.2	Mounting procedure	26
9.3	Mounting instruction plate	27
9.4	Marking Hydrostatic Release Unit (HRU) expiry	27
9.5	Marking vessel name	28
10	Maintenance	29
10.1	Self Test & inspection	29
10.2	Mechanical inspection	31
10.3	HRU replacement	32
10.4	Battery replacement	33
10.5	Servicing	33
10.6	Transportation	33
10.7	GMDSS inspections	34
11	How does it work?	35
12	Technical specification	36
12.1	Declarations of Conformity	37

13	Appendix – Satellite Systems	41
14	United States EPIRB registry system.....	43
15	Product Warranty	44
16	End of Life Statement	45

1 RECOMMENDATIONS AND SAFETY NOTICES

- **This EPIRB is an emergency device for use only in grave and imminent danger.**
- **False alerts endanger lives. Help to prevent them; understand how to activate and de-activate your equipment. Intentional false alerts may involve penalties.**
- **Read the complete manual before installing, testing or using the EPIRB.**
- **Ensure you test the EPIRB monthly – see section 10.1**
- **Ensure the EPIRB is registered with your local authorities (Flag State nation) – see section 2.**
- **The EPIRB contains no user serviceable parts. Do not open. Return to your dealer for battery replacement or other service.**
- **This device contains Lithium batteries; do not incinerate, puncture, deform or short-circuit. Take care if you need to dispose of these batteries or the complete EPIRB – refer to section 10.3**
- **This device emits radio frequency radiation when activated. This radiation is not classed as harmful; however, it is advisable not to handle the antenna while the unit is activated.**
- **It is advisable not to stare directly at the strobe LEDs.**

2 MANDATORY REGISTRATION

You must register your EPIRB with the appropriate authorities. Failure to register may slow the rescue and lead to loss of life. In the USA failure to register may result in a fine. In the UK you are legally required to register your EPIRB.

2.1 Overview

Every EPIRB is pre-programmed with a unique identity before it reaches the customer. This is done by the manufacturer or, in some cases, the distributor. The identity includes a 3 digit country code. This is the country that takes responsibility for storing that particular EPIRB's registration details. In most cases this is the country to which the vessel is flagged. The country programmed into your EPIRB can be found from its rear identity label. You **must** register with this country.

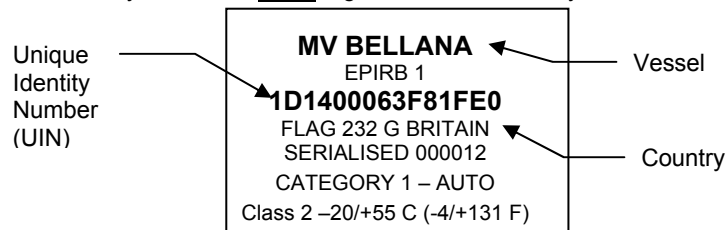

When you activate your EPIRB in an emergency, the nearest maritime search and rescue coordination centre (MRCC) will receive the message and decode the country code (eg 232). They will then access the registration database for that country and expect to find details of your vessel, its radio equipment and who to contact. If they fail to find this information, this may slow down any rescue.

2.2 How to register

Three registration forms are provided, two are for future use and one must be completed immediately. These forms are pre-printed with your EPIRB's identity; all you have to do is complete details of your vessel and provide contact numbers. Wherever possible the forms are also pre-printed with the correct mailing address and a faxback number. If your form does not have a mailing address, contact your supplier. When you have completed the form, you can choose to fax it or mail it.

It is usual to receive confirmation when you register. In the UK and USA you will also receive a "Decal" sticker which you must fit to the EPIRB itself. The Decal is proof of registration. Not having a Decal is an offence.

Useful registration contacts are:

USA Sarsat Beacon Registration
E/SP3, RM3320, FB-4
NOAA, 5200 Auth Road
Suitland MD 20746-4304
Tel 888 212 7283 Fax 301 568 8649

UK EPIRB Registry
HM Coastguard (Southern)
Pendennis Point, Castle Drive
Falmouth TR11 4WZ
Tel 01326 211569 Fax 01326 319264

Details of the North American on-line registration systems are given on Page 43.

COSPAS-SARSAT provide registration details for many countries; use the web address www.cospas-sarsat.org and follow the links to *406 MHz Beacons* and *Registration*; alternatively, there is direct access to the database on www.406registration.com

2.3 Warranty form

Please complete the warranty form supplied and fax or mail it to McMurdo. Failure to do this may delay any future warranty claim.

2.4 Radio licence

An EPIRB is a radio transmitter and must therefore be added to your radio licence. If you have been allocated a radio callsign, then you already have a radio licence for your VHF or MF radio set. You should update your licence to include your EPIRB. For further details see your licence or use these contact numbers:

USA FCC Tel : 888 225 5322 Website : www.fcc.gov/Forms/Form506\506.pdf
UK Ship Radio Licensing, Radio Licensing Centre, The Post Office, PO Box 1495
Bristol BS99 3QS Tel: 0870 243 4433 Fax: 0117 975 8911
Minicom: 0117 921 9550 Website: www.radiolicensingcentre.co.uk/

2.5 Sale or transfer

EPIRBs registered in the USA, Canada, UK and Australia do not need to be re-programmed when transferred to a new vessel. Simply complete another registration form to inform the authorities of the transfer. Use one of the spare forms provided or contact McMurdo for a blank form. (See warranty section at rear for address).

For most other countries, the EPIRB must be re-programmed with either the new vessel's Maritime Mobile Station Identity (MMSI) or its radio callsign, whichever is required by the country controlling the new vessel.

Since the EPIRB identity contains a country code, it follows that changing the flag state of the vessel also means the EPIRB must be re-programmed. Programming can be carried out at McMurdo or any of our designated agents. For details of your nearest

agent, either contact McMurdo using the details in the warranty section, or visit the McMurdo web site at www.mcmurdo.co.uk.

2.5.1 Mandatory information for Oceania

(The term *Oceania* is normally used to designate all the islands of the Central and the South Pacific including Australia and New Zealand.)

Advice to owners of Emergency Position Indicating Radio Beacons:

Registration of 406 MHz satellite Emergency Position Indicating Radio Beacons (EPIRB) with the EPIRB Registration Section of the appropriate Maritime Safety Authority (MSA – see below) is mandatory because of the global alerting nature of the system.

The information provided in the registration card is used only for rescue purposes. Fill in the owner registration card immediately on completion of the sales transaction. Mail the registration card immediately.

If the beacon is to enter service immediately, complete the registration card and fax the information to the MSA. The original card must still be mailed to the MSA for hard-copy reference and filing.

If the current owner is transferring the beacon to a new owner, the current owner is required to inform the MSA by letter, fax or telephone of the name and address of the new owner.

The subsequent owner of the beacon is required to provide the MSA with the information shown on the owner registration card. This obligation transfers to all subsequent owners.

*The MSA is the Australian Maritime Safety Authority or the Maritime Safety Authority of New Zealand, as appropriate, whose respective fax numbers are 06 257 2036 (Australia) and 04 382 6482 (NZ).

3 DESCRIPTION

The EPIRB is a powerful self-contained distress transmitter. It is powered by a Lithium battery that has a replacement interval of 5 years. An EPIRB is intended to be a one-shot device; once activated it will operate for at least 48 hours. It operates best while floating in water, but it can also be operated while on board a vessel or in a liferaft.

The key components of your EPIRB are:

Antenna	This is a flexible whip. It must be near vertical when operating. If the antenna gets bent, gently straighten it out.
Strobe light	These are the bright white LEDs visible through the clear lens dome. When the EPIRB is activated they will flash every few seconds.
Red LED	Visible through the clear lens dome at the rear of the EPIRB. This stays on or flashes to show which mode the EPIRB is in.
Green LED	When fitted (beside the red LED), this flashes when the GPS acquires a position fix.
Sea switch	The two studs on the sides of the EPIRB are sea switch contacts. Submerge these in water to activate the EPIRB automatically. Keep these contacts clean – see section 10.2
Activation switch	Pull the tear-off tab upwards to release the switch, then push the switch in and move it fully left.
Test button	This button enables the user to run test sequences to verify the readiness of the EPIRB.
Lanyard	Pull the lanyard spool down to free it. Use the cord to tether the EPIRB to a survival craft.

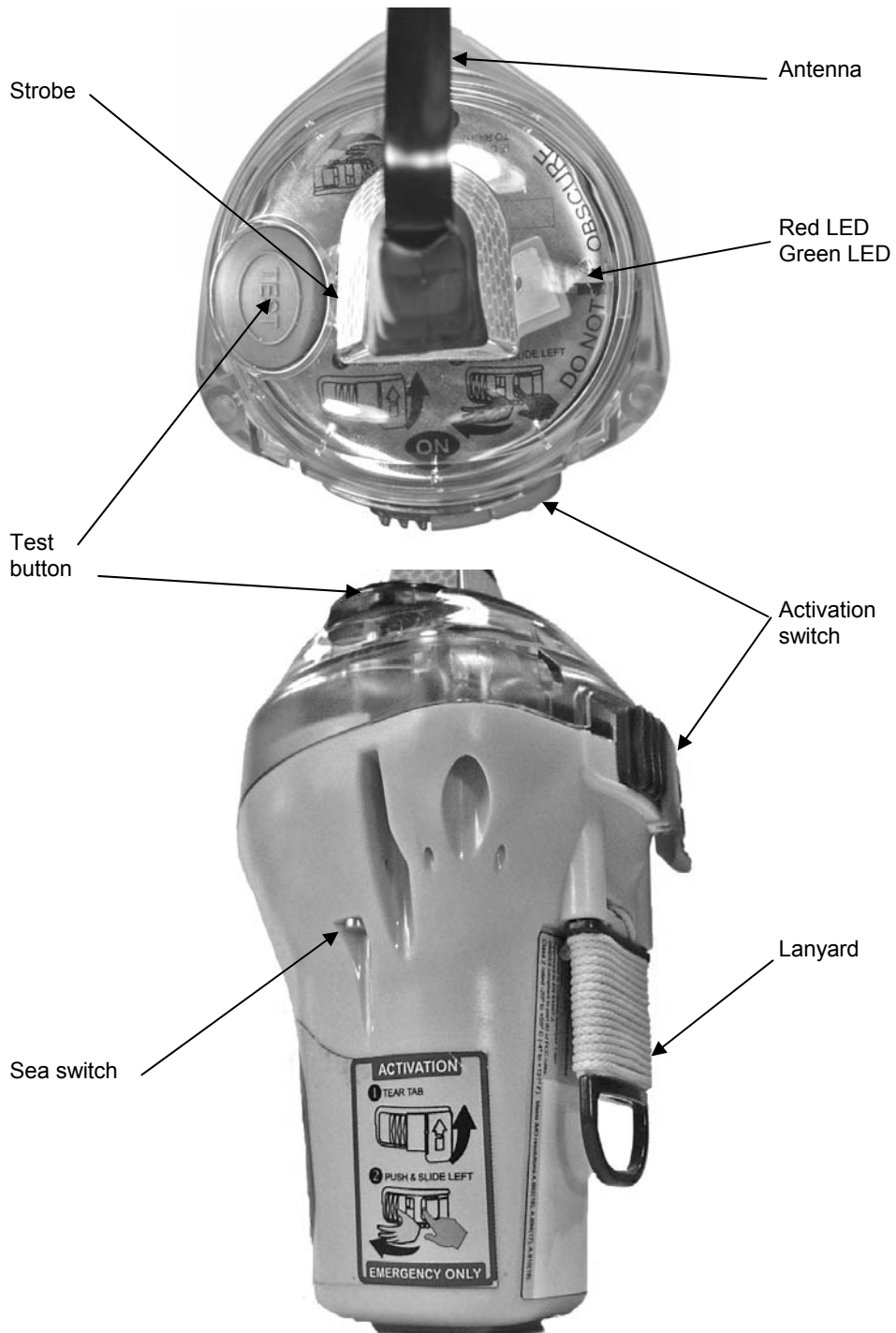

3.1 Bulkhead bracket

If you purchased the manually activated EPIRB version, this is normally supplied with a bulkhead mounting bracket (see section 8). The EPIRB is released by pulling out a R-clip.

The bulkhead bracket should be sited in plain view near an emergency exit.

To avoid accidental activation if the EPIRB is removed from its mounting, the bracket is in two sections. The removable collar section contains the deactivating magnet for the EPIRB, so the demounted EPIRB with its attached CARRYSAFE collar cannot be activated by moisture. This allows it to be removed easily and transported in, for example, a wet grab bag.

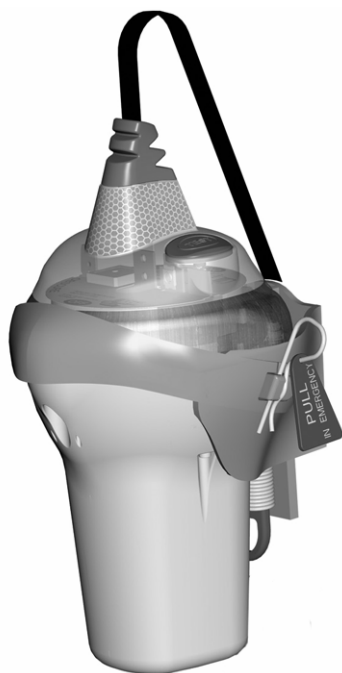

EPIRB in CARRYSAFE removable collar



Press to release CARRYSAFE collar

Fixed bulkhead mount

WARNING

The EPIRB will NOT be activated by moisture while it is in the bracket or in the CARRYSAFE collar (but it may activate if placed in close proximity to a magnet). The EPIRB must be removed from all parts of the bracket; it will then activate if immersed or if switched on manually.

3.2 Float-free enclosure

If you purchased the automatically activated version ('a' suffix), also known as the "float-free" version, then your EPIRB is supplied in a plastic enclosure (see section 9). This is much more than just a protective housing; it contains a spring-loaded lever which automatically pushes the enclosure lid off and releases the EPIRB if your vessel sinks. This automatic ejection is controlled by a device called a Hydrostatic Release Unit (HRU). If the enclosure is sinking then before it reaches 4 metres (13 feet) depth the HRU which cuts a plastic rod that retains the lever; this ejects the lid and releases the EPIRB which floats to the surface and switches on automatically, as shown below:

1. As the vessel sinks, the enclosure fills with water. The HRU contains a blade which is released due to water pressure acting on a diaphragm. Before it reaches a depth of 4 metres, the HRU will operate and cut the plastic rod, releasing the coil spring.
2. The spring pushes the EPIRB and the enclosure lid outwards. As the lid pivots off it disengages from the moulding lip that helped hold it in place. The lid is weighted so it rolls over and falls away.
3. As the EPIRB floats away, it moves out of range of the magnet. Once away from the magnet its sea switch becomes armed.
4. The sea switch activates. The EPIRB then floats on the water surface with its strobe light flashing. After 50 seconds it makes its first distress transmission.

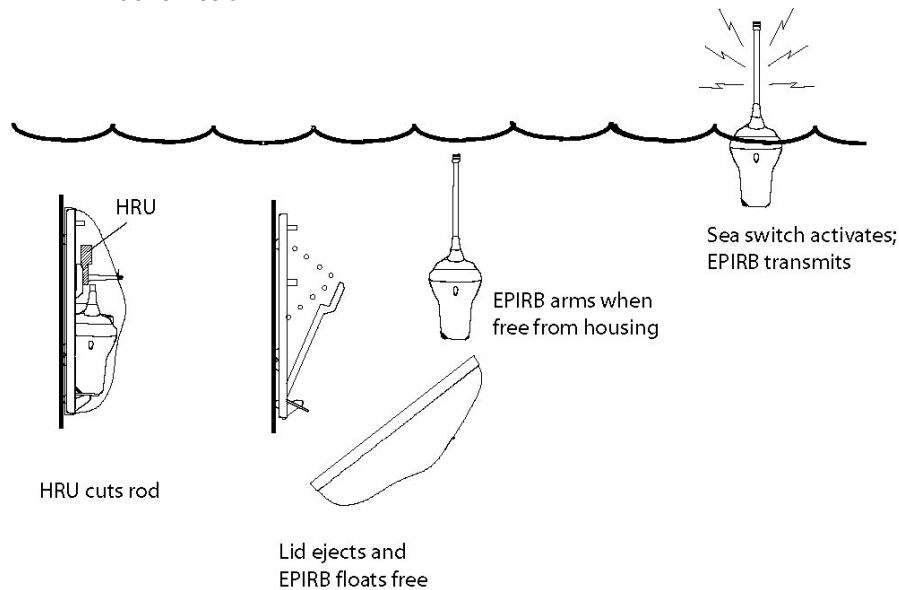

If you need to activate your EPIRB manually, it can be freed from the enclosure after pulling out the R-shaped retaining pin and removing the lid.

4 CONTROLS

4.1 Activation switch

This slide switch is protected against accidental activation by a red tear-off seal which indicates if the EPIRB has been activated previously.

The EPIRB can be activated manually by tearing the seal upwards, depressing the locking button on the switch and sliding the switch to the left.

When the EPIRB is activated the strobe will start to flash immediately, but the EPIRB will not make any distress transmissions for 50 seconds. This gives you a chance to turn off if you activated it accidentally. During this time the red LED illuminates continuously. When the red LED starts to flash, the 50 seconds delay has passed and distress transmissions have started.

4.2 TEST button

This control allows various test sequences to be run on the EPIRB. Details of these tests are given in Section 10.1.

4.3 Sea switch

It is important to realise that the only time the EPIRB is completely off is when it is fitted in its mounting bracket or enclosure. As soon as you take it out, a magnetic switch activates and puts the EPIRB into its "ready" state. It will not drain the battery in this state, but it will turn on automatically if the sea switch contacts are immersed in water. The sea contacts are the two studs, one on each side of the EPIRB.

Although you can control the EPIRB manually with the activation switch, the sea switch overrides any manual settings. For the manual switch to operate properly the EPIRB must first be dry so that the sea switch is de-activated.

To ensure the sea switch operates properly in rough seas, it has a built-in time delay. It has to be wet for at least 2 seconds before it will activate and it has to be dry for at least 8 seconds before it will de-activate.

4.4 LEDs

4.4.1 Strobe (white)

The strobe is the visual means of locating the EPIRB. When activated, the strobe flashes (approximately) 21 times per minute, with a pause during the time when the EPIRB is transmitting on 406 MHz.

4.4.2 Red LED

The red LED is used to indicate transmissions by the EPIRB. When activated, it flashes alternately with the strobe to indicate a good transmission on 121.5 MHz. Every 50 seconds it illuminates for 2 seconds to indicate a good transmission on 406 MHz; immediately before the transmission the LED flashes rapidly as a warning to the user.

When the EPIRB is first activated the red LED is illuminated continuously until the EPIRB begins to transmit, when it begins to flash.

4.4.3 Green LED (fitted to Smartfind Plus only)

The green LED flashes alternately with the strobe to indicate that a valid position has been obtained by the GPS receiver. Every 50 seconds it illuminates for 2 seconds to indicate that the position is being transmitted on 406 MHz.

Every 20 minutes the GPS receiver updates its position information. If a fix is not obtained, the green LED stops flashing, and illuminates only every 50 seconds (when the previous position information is transmitted).

All LEDs also indicate the results of self-test – refer to section 10.1

4.4.4 Interpreting the LEDs:

There are three principal indications to the user:

- If the red LED is ON continuously, the EPIRB is active but has not yet made a transmission. There is time to turn it off without causing an alert.
- If the red and green LEDs flash together and alternate with the strobe flash, the EPIRB has a valid GPS position which it is transmitting regularly. This is the normal operating condition which requires no user action.
- If the red and green LEDs flash at different rates, the EPIRB is attempting to obtain a GPS fix. If this indication persists, it is advisable to move the EPIRB to a different location; something may be affecting its ability to see the GPS satellites.

The LEDs can give many other indications; these are principally for diagnostic purposes.

4.5 Buzzer

The EPIRB contains a buzzer to give audible feedback.

When the EPIRB is activated the buzzer pulses rapidly (whilst the red LED is ON continuously) as a warning that the EPIRB is about to transmit. Once the first transmission is complete, the buzzer sounds synchronously with the strobe.

The buzzer is also used to indicate the results of self-test.

5 OPERATING PROCEDURE

An EPIRB is a piece of life saving equipment. Its sole purpose is to call for help. It must only be used in situations of grave and imminent danger. Misuse can involve a severe penalty.

5.1 Sinking

If you have a category 1 “float-free” enclosure (see marking on enclosure label), then if your vessel sinks, the EPIRB will automatically release itself from its enclosure before it reaches a depth of 4 metres. The EPIRB will float to the surface and start to operate because its sea switch is activated.

If possible, the EPIRB should be recovered and tied (using its lanyard) to the survival craft. An EPIRB is meant to mark survivors, not the accident scene.

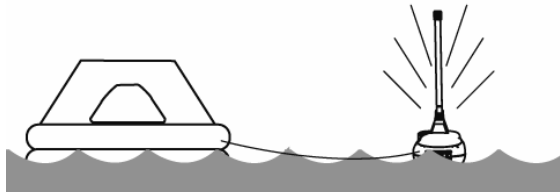

For best operation leave the EPIRB floating in the sea near the survival craft, as this is the condition for which it was designed and tested.

NOTE: Satellite coverage at the time an alert is transmitted and, if activated onboard a ship or raft, overhead obstruction on the ship or raft, may affect whether and how soon an alert is received by the satellite system.

5.2 Abandon ship

If the vessel is sinking and there is time to fetch the EPIRB then this should always be done. Release the EPIRB from its mounting bracket as described in section 5.4 or 5.5 and carry it to one of the liferafts. Once the liferaft is in the water, uncoil the lanyard and tie it to the liferaft, then throw the EPIRB overboard so that it floats next to the liferaft. The EPIRB will operate because its sea switch will activate.

5.3 GPS Operation (Smartfind Plus only)

The GPS receiver needs a clear view of as much sky as possible in order to acquire signals from sufficient satellites to determine its position. Should it fail to do this, the beacon will still transmit the 406 MHz distress signal, and its position will be determined by the COSPAS-SARSAT satellites using Doppler techniques.

Getting the best from your EPIRB

Your EPIRB is designed and optimised to be used floating in the sea. However, if you have to use it in other situations, this section provides guidance on how to get the best from your EPIRB.

Aboard ship:

DO:

- Place the EPIRB in the open, clear of overhangs
- Keep the EPIRB upright (hold it if necessary)
- Switch on the EPIRB

DON'T:

- Place the EPIRB close to large structures
- Lay the EPIRB on its side
- Place the EPIRB under cover
- Secure the EPIRB lanyard to the vessel



In a liferaft:



DO:

- Make sure you switch on the EPIRB
- Hold the EPIRB up as high as possible.

Note: the high intensity flashing strobe light may cause discomfort if viewed for prolonged periods.

We recommend that the EPIRB is used floating in the sea

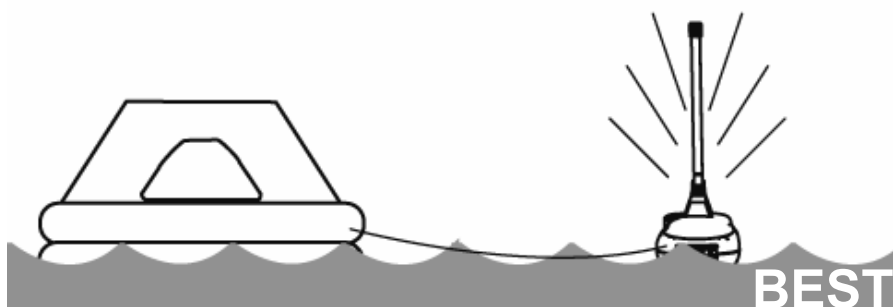

5.4 Releasing EPIRB from a bulkhead bracket

If you have an EPIRB fitted into a bulkhead bracket, pull the R-clip out of the bracket to release the retaining strap. Hold the antenna to prevent it springing loose and lift the EPIRB out of the mounting points.



5.5 Releasing EPIRB from an enclosure

If your EPIRB is fitted inside a full enclosure, first remove the R-clip from the retaining rod, then pull off the enclosure cover and remove the EPIRB.

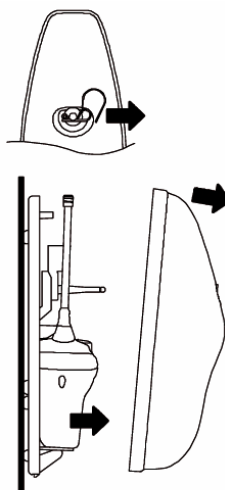

5.6 Manual activation

If the vessel is not sinking but there is imminent danger, remove the EPIRB from its bracket and activate it manually as shown below. Note that once activated it will flash immediately, but it will not transmit a distress call for 50 seconds. This gives you a chance to turn it off if you activated it in error.

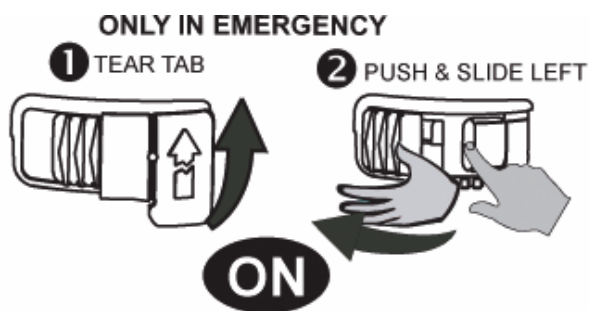

Once activated the EPIRB **must** have its antenna as upright as possible and it must have a clear view of the sky for proper operation. Laying it on its side or placing it next to a metal bulkhead will impair its range and may fail to alert the rescue services. Avoid handling the antenna, as this will also impair performance.

5.7 Deactivation

If your EPIRB has been activated for a cumulative period in excess of 6 hours then its battery should be replaced. This is necessary to ensure that in an emergency it will operate for the full 48 hours required by international regulations. See section 10.4 for battery replacement instructions.

If the EPIRB was activated by mistake or if the emergency ends then the EPIRB can be reset back to its "ready" state as follows:



If EPIRB is still flashing then it has a fault. Refer to section 6 on False Alerts.

5.8 Re-fitting EPIRB

5.8.1 Refitting into bulkhead bracket

The EPIRB is now in its "ready" state, but its sea switch is still armed and will activate if it gets wet. To de-activate the EPIRB fully it must be replaced in its mounting bracket, where a magnet in the bracket will make the EPIRB safe.

Hold the bracket collar open and drop the EPIRB into the bracket. The slots in the EPIRB fit over the locating lugs in the bracket.

Hold the collar shut and fit the R-clip to secure the EPIRB. Fold over the antenna and locate the end moulding in the retaining slot.



Align
slot
with
lug

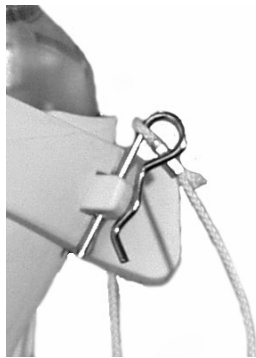

Fit R-clip



Locate end of
antenna in slot

5.8.2 Re-fitting into enclosure

- Referring to the illustration, place the EPIRB on its side in the enclosure. As illustrated, the TEST button is furthest from the back of the enclosure.
- Engage base of EPIRB into the recess in the lever arm.
- Push the EPIRB into the enclosure to engage the retaining clip.
- Bend the antenna as shown and retain it in the recess.
- Refit cover squarely, engaging the guides at the top end and the rod through hole in cover.
- Locate cover onto backplate, then snap down over locating lug. Check that the cover is correctly located (see following page).
- Refit R-clip through hole in end of release rod.



CAUTION
Failure to fit EPIRB correctly may impair its ability to float free in an emergency

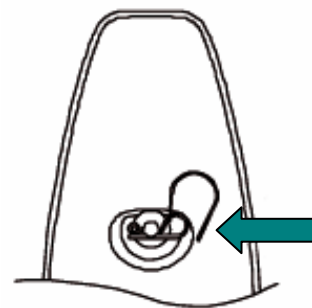
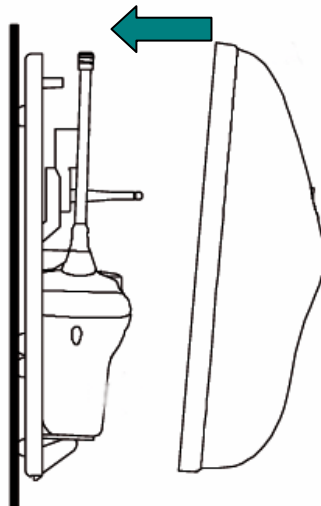



Cover correctly fitted to base

6 FALSE ALERTS

False alerts are a serious problem for the rescue services. About 90% of EPIRB-initiated distress alerts turn out to be false alerts. If your EPIRB should cause a false alert, follow the instructions below.

6.1 Stand down rescue services

It is most important that you contact the nearest search and rescue authorities and tell them it was a false alert, so that they can stand down any rescue services. Use any means at your disposal to make contact. Often this can be by VHF radio to the local coastguard or mobile phone if you are within coastal range, but MF/HF DSC and Inmarsat A, B, C, M may also be used.

Useful contacts:

Country	Region	Telephone	What to report
USA	Atlantic / Gulf of Mexico	(757) 398-6390	EPIRB Unique ID (UIN)
	Pacific	(510) 437 3700	Vessel name/ID
	From any location	(800) 323 7233	Date, time & duration
UK	From any location	01326 317 575	Cause of activation Location when activated

6.2 Turn off the EPIRB

If the EPIRB was activated by mistake, then turn it off:

- Remove the EPIRB from any water and dry its sea switch contacts.
- Wait about 8 seconds for the sea switch to de-activate.
- If the EPIRB is still flashing then it must have been turned on manually
- Slide the activation switch fully to the right.
- The EPIRB should now stop flashing.
- Refit the EPIRB correctly into its mounting bracket or enclosure.

Modern EPIRBs have sea switches and it is not uncommon for the sea switch to activate in rough seas or heavy rain simply because the EPIRB has been badly fitted in its mounting bracket. The EPIRB bracket contains a magnet to hold the EPIRB in an off state. If the EPIRB is wrongly fitted the magnet has no effect, so heavy seas may activate the sea switch. The cure is to ensure the EPIRB is correctly fitted as shown in section 5.8.

6.3 Dealing with a transmitting EPIRB

In the unlikely event that your EPIRB develops a fault and will not turn off, then prevent its radio signal from reaching the satellite using one of the following methods:

- Cut off or fold down the antenna. Wrap the EPIRB in metal foil and take it below decks.

or

- Cut off or fold down the antenna and place the EPIRB in a metal container or locker.

Take care when dealing with the antenna. Handle the antenna as little as possible. Refer to Section 1 for warnings.

Leave the EPIRB in this condition for 3 days until its battery is dead, then refer to section 10.5 for instructions on returning the EPIRB for servicing. See also section 7.

7 FULLY DISABLING AN EPIRB

In the unlikely event that your EPIRB refuses to turn off then it may have a fault. Procedures for dealing with a faulty EPIRB are covered in section 6 on false alerts; in simple terms you should do the following:

- De-activate the EPIRB as described in section 6.2
- Suppress its signal by removing the antenna and wrapping the EPIRB in metal foil, as described in section 6.3
- Leave for 3 days until the battery is used up.

WE DO NOT RECOMMEND ANY OTHER COURSE OF ACTION.

However, if it is absolutely necessary to fully disable an EPIRB (by unplugging its battery), proceed as follows:

- Take the EPIRB below decks into a dry area.
- Locate a cross-headed screwdriver.
- Unscrew and retain the 3 sealing screws.
- Lift the lens dome off. This will lift the circuit board.
- **Avoid touching the circuit board if possible**
- Using fingers, unplug the three white battery connectors.
- The flashing will now cease.
- Collect all the parts and return them to your nearest service agent.

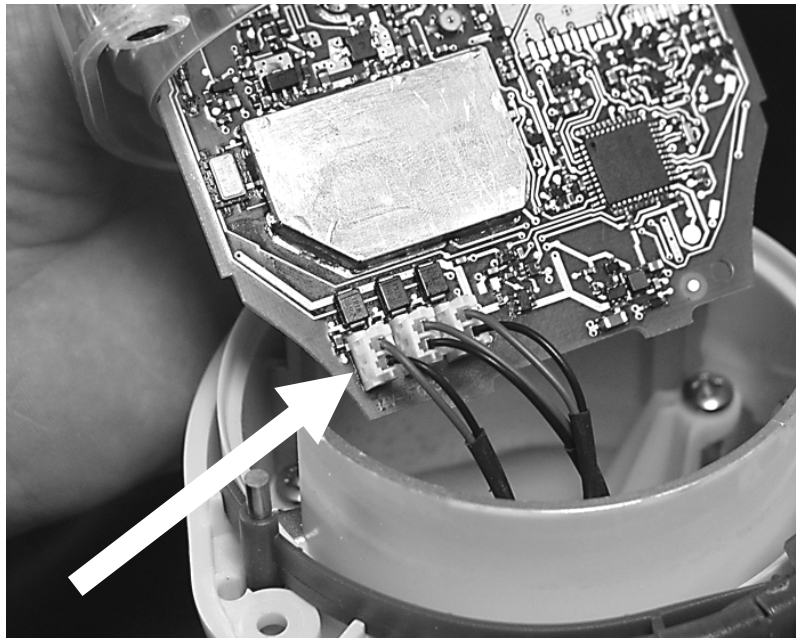

8 BULKHEAD BRACKET INSTALLATION

8.1 Siting

The bulkhead bracket should ideally be sited in plain view near an emergency exit. When choosing a suitable mounting position you should also consider:

- Ease of access in an emergency.
- Mount at least 1 metre (3') from any compass equipment.
- If there is any likelihood of the EPIRB being replaced in its bracket after activation then ensure that the antenna has as clear a view of the sky as possible.

8.2 Mounting procedure

The bulkhead bracket is supplied with four stainless steel screws 25mm (1") in length. The bracket mounts against a flat surface using 4 fixing points. Offer the bracket into the chosen position and mark through the mounting slots and drill 3mm (1/8") holes.

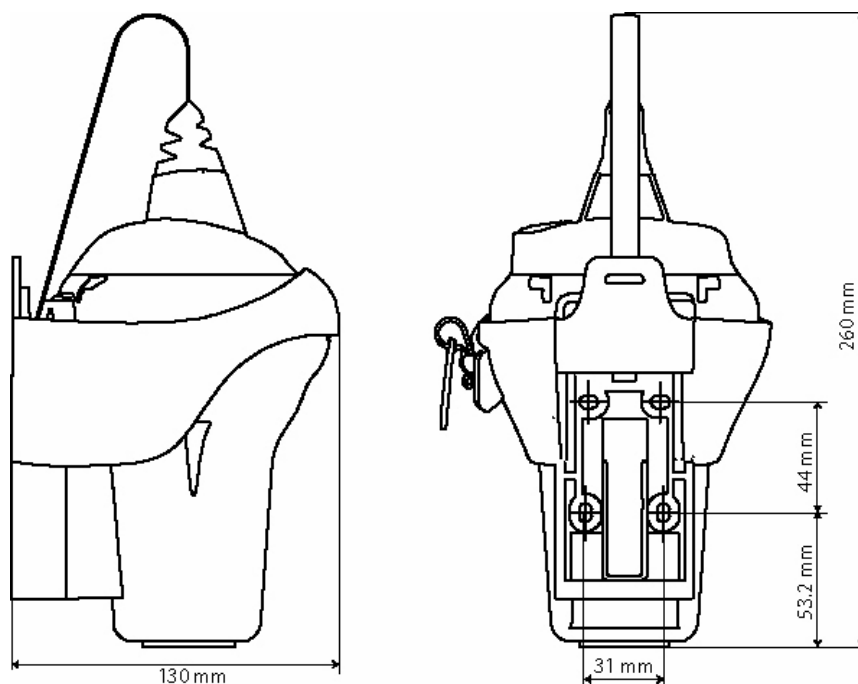

8.2.1 Mounting instruction plate

The EPIRB is supplied with a self-adhesive instruction plate, which has basic visual instructions showing how to operate the EPIRB in an emergency.

Mount the instruction plate next to the EPIRB so that it is easily visible in an emergency.

During vessel maintenance, ensure the plate does not get painted over or cleaned down with strong degreasing solvents.

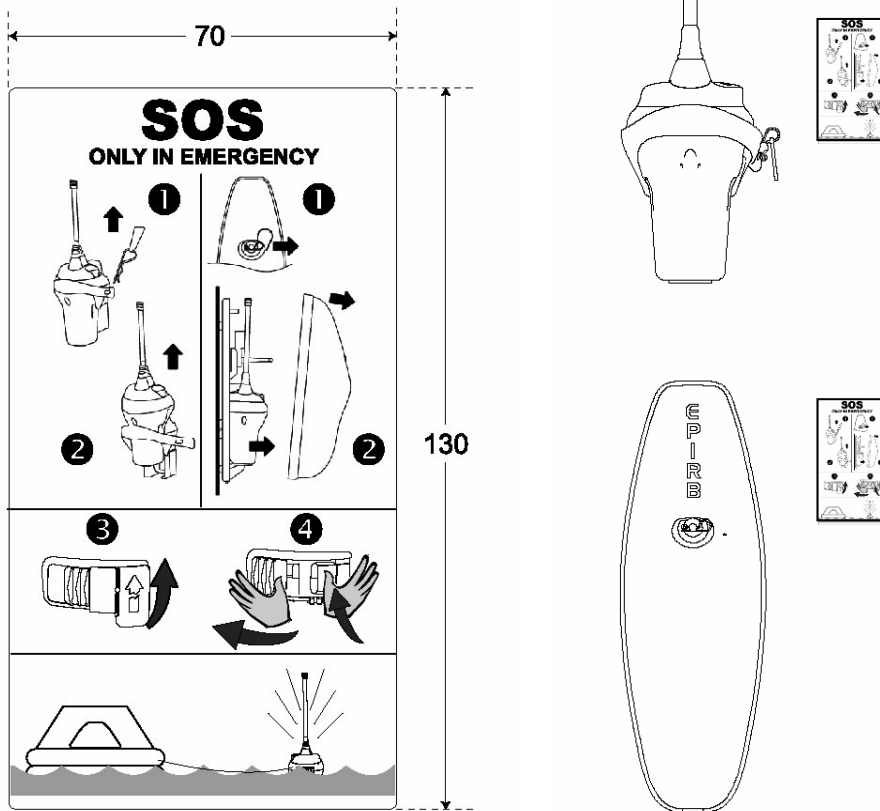

Mount instruction plate next to housing

9 ENCLOSURE INSTALLATION

9.1 Siting

The enclosure should be mounted upright against a vertical bulkhead. Alternately, it may be mounted horizontally on a flat surface, such as a cabin roof. No other orientations are recommended.



If you have a float-free EPIRB it is critical that you choose a position where the released EPIRB will not get trapped by overhangs, rigging, antennas etc, should the vessel ever sink. An expanse of flat surface is required to allow the enclosure lid to eject. Use the list below to choose a suitable mounting position:

- Mount on the outside of the vessel's structure, as high as possible.
- Mount close to the vessel's navigation position.
- Consider ease of access in an emergency.

AVOID:

- Positions with insufficient space for lid ejection and maintenance.
- Positions within 1m (3') of any compass equipment.
- Mounting within 2m (6') of any Radar antenna.
- Direct impact from waves
- Siting where damage is likely.
- Exhaust fumes, chemical and oil sources.

9.2 Mounting procedure

The enclosure mounts against a flat surface using 4 fixing points. See illustration for mounting dimensions, or use the backplate of the enclosure as a marking guide. To do this, pull out the R-shaped clip and remove the enclosure lid. Note how the EPIRB fits then remove it to somewhere dry (its sea switch is now armed).

Offer the back plate into the chosen position and mark through the mounting holes. The enclosure is supplied with a set of 25mm (1") stainless steel fixings. If you are using the nuts and bolts, drill 6mm (1/4") holes where you have marked. You will need a 4mm Allen key to tighten the bolts. If the rear of the mounting surface is inaccessible, use the self-tapping screws supplied. Always fit washers under heads of the screws to avoid damaging the plastic.

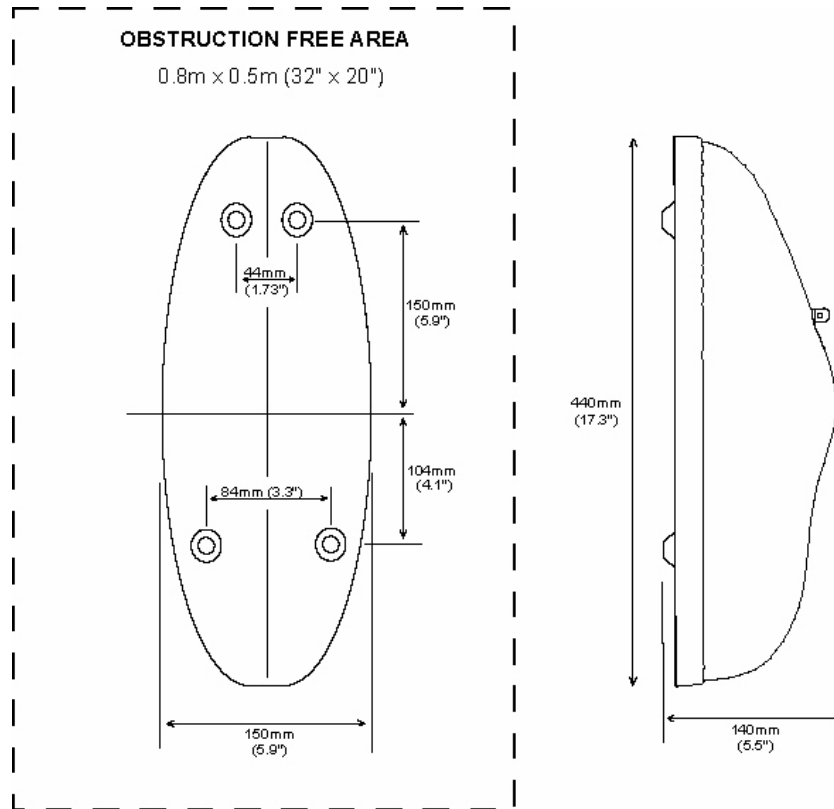

9.3 Mounting instruction plate

The EPIRB is supplied with a rigid plate giving visual instructions on how to operate the EPIRB in an emergency. Mount this next to your EPIRB as explained in section 8.2.1.

9.4 Marking Hydrostatic Release Unit (HRU) expiry

If you are installing a float-free EPIRB you **must** now mark the HRU expiry date. The HRU has a 2 year in-service life which starts as soon as it gets exposure to a marine environment. Hence the 2 years starts at installation and it is left to the customer to mark this date during installation. A date 2 years into the future should be marked on the HRU body and copied onto the label on the side of the enclosure. The HRU is marked by cutting out the corresponding dates on its label, as shown on the separate leaflet.

The enclosure should be marked using the alpha-numeric stickers provided, then covering them with the clear adhesive label provided (but see 9.5 first). The preferred date format is month and year, for example : JUN 2006.

9.5 Marking vessel name

In many countries it is usual to have your EPIRB programmed by your supplier (see registration section). Your supplier will then mark all the EPIRB labels accordingly. However, if your EPIRB was purchased in the USA, Canada or UK then your EPIRB will have all the necessary markings except for vessel name. In these countries it is usually left to the customer to mark the vessel name during installation.

It is strongly recommended (and is mandatory in some countries) that the vessel name is marked on the rear of the EPIRB itself and also on the enclosure, if you have one. Use the alpha-numeric stickers provided to mark the vessel name (or its abbreviation) on the top line of the EPIRB's rear label and again on the enclosure label. Protect the markings with a section of the clear adhesive label provided.

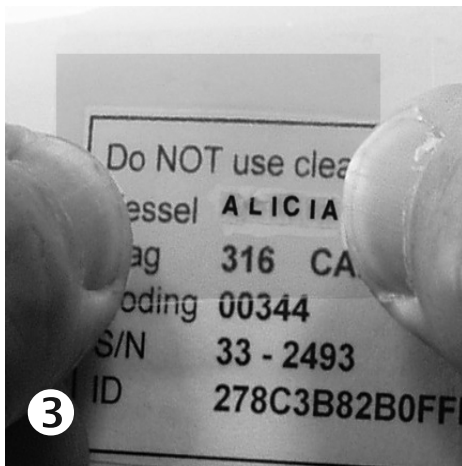
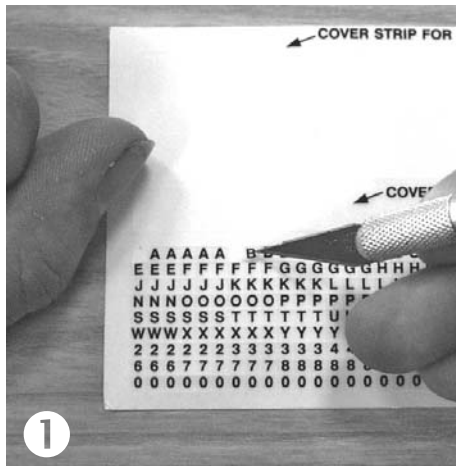

1. Pick off required letter (a small knife blade works well)
2. Apply letter to label
Repeat until name is complete
3. Cover letters with clear label

10 MAINTENANCE

10.1 Self Test & inspection

As an important item of safety equipment, your EPIRB should be checked regularly. The EPIRB has a built-in test capability that can be used as a confidence check. This self-test confirms that the battery is healthy, that the GPS receiver and both distress transmitters are functional and that the strobe light is operational. The self-test should be performed **monthly**, but not more frequently. It should be performed during the first 5 minutes of the hour, to minimise disturbance on the emergency channel.

10.1.1 Standard Self Test

1. Press the TEST button until the red LED lights, then release the button.
2. The EPIRB will test its internal components and then make test transmissions at 121.5 and 406 MHz whilst monitoring the transmitter output.
3. If all tests are successful, the buzzer will sound and the red and white strobe LEDs will flash together a number of times.
4. If any test is unsuccessful, nothing will flash and the red LED will go out.

Operation of this test for the Smartfind Plus is identical, except that the green LED will flash (or not) in step with the red LED.

5. The number of times the LEDs flash is an indication of the accumulated time the battery has been in use

Accumulated Battery Use (hours)	Number of flashes/beeps
0 to 4	3
5 to 6	2
More than 6	1

REGARDLESS OF THE BATTERY STATE, THE EPRIB SHOULD ALWAYS BE ACTIVATED IN AN EMERGENCY – IT MAY STILL GENERATE AN ALERT.

If the EPIRB fails Self Test, it must be serviced.

10.1.2 Power consumption warning

If the TEST button is held down after any test has completed, a warning is given: after 20 seconds, the red LED flashes rapidly and the buzzer sounds. This indicates that battery capacity is being reduced for no reason.

If this warning persists after the TEST button is released, the EPIRB is faulty and must be serviced.

10.1.3 GPS operation test (Smartfind Plus only)

To comply with COSPAS-SARSAT regulations, the Smartfind Plus EPIRB is also capable of checking the correct operation of the GPS receiver. This test consumes significant reserve capacity of the EPIRB battery, consequently it can only be performed a fixed number of times. It is recommended that this test is performed only if the performance of the GPS receiver is suspect.

This test must be performed only in a location where the beacon may be expected to acquire a GPS position – refer to page 12 for advice.

1. Press the TEST button until the red LED lights, then release the button. Wait while the Self Test routine runs, then immediately the strobe flashes press the TEST button and hold it down for about 15 seconds until the red LED lights again. (If the strobe does not flash, the Self Test failed. In such a case, this test cannot be performed.)
2. Provided that the Self Test was successful, the Smartfind Plus will start the “Long GPS Self Test” mode. The buzzer will sound twice, the red LED will stay lit and the green LED will begin to flash. The TEST button may be released at this point.
3. This test takes 15 minutes to complete. During this time, do not shield the EPIRB and do not stand over it.
4. If the GPS receiver acquires a position, the green LED will light continuously and the buzzer will sound 10 times. If the receiver fails to acquire a position, the red LED will light continuously and the buzzer will sound 10 times.
5. Whether the test passes or fails, the white strobe LEDs flash to indicate how many Long GPS Self Test routines remain available.

If the EPIRB passes Self Test but fails the Long test, it is advisable to have it serviced. It will still generate an alert in an emergency, but it may not provide GPS-precise position information; this may delay a rescue, as the possible search area is much larger.

NOTE: New beacons have 10 test cycles available. When the Smartfind Plus battery is changed, it is the responsibility of the service agent to ensure that the Long Test cycle counter is reset, as otherwise this test may not be available.

WARNING: While the EPIRB is running this test it cannot generate a distress alert. (Once the test is complete the EPIRB returns to normal operation without any operator intervention.) It is therefore recommended that this test is performed only under conditions where an emergency is unlikely to arise.

If necessary, this test may be terminated (without performing the check) by holding down the TEST button for approximately 5 seconds until the red LED goes out.

10.2 Mechanical inspection

During these monthly checks you should take the opportunity to inspect the EPIRB and its mountings visually for deterioration or damage.

Note that the EPIRB is designed to allow water to circulate around the outer edge of the dome (inside the outer clear plastic edge but outside the waterproof seal), consequently a volume of water in this area is of no consequence.

On the EPIRB itself check the following:

- Inspect the EPIRB for any obvious damage
- Check that the lanyard is not tied to the vessel structure
- Check the battery is within its expiry date
- Check that the sea switches are clean and free from paint or grease
- Check that the antenna has not been creased, so that it erects to a near-vertical position when released.

If during these checks it is discovered that the frangible seal has been broken, then the EPIRB may have been activated. The battery condition is thus suspect, and the battery should be replaced at the earliest possible opportunity. It is, however, possible to verify the condition of the battery to a limited extent by using the indication of the self-test, as described in section 10.1.1. If the LEDs flash more than once, then there is a good chance that the battery will provide the specified performance. **IT IS RECOMMENDED THAT THE BATTERY IS REPLACED REGARDLESS OF SUCH VERIFICATION.**

If you have a bulkhead bracket:

- Check the EPIRB is correctly fitted and secure in its bracket
- Check that the two halves of the bracket are securely connected

If you have an enclosure:

- Check the HRU is within its expiry date
- Confirm the cover can be easily removed
- Ensure the EPIRB base is correctly fitted into the D-shaped recess and that the antenna is correctly stowed

If the EPIRB or its mounting needs cleaning then this should be done using warm soapy water and a damp (not wet) cloth. Do not use strong detergents or solvents.

<p style="text-align: center;">Do not paint the EPIRB or its mounting Do not clean with detergents or solvents During vessel cleansing or painting remove the EPIRB and its mounting.</p>
--

10.3 HRU replacement

If you have an EPIRB in an enclosure marked Category 1 then it contains a Hydrostatic Release Unit (HRU). This has a 2 year replacement interval. **WARNING: Failure to replace the HRU at 2-yearly intervals may result in it not actuating correctly and releasing the EPIRB in an emergency.** The expiry date, which is marked on the HRU and on the enclosure side label should be checked regularly.

When the HRU expires you can obtain a replacement at a local marine store; ask for a McMurdo BreaktHRU HRU Replacement Kit (Part No. 82-962-001A). The kit is complete with breakable plastic rod, date labels and instruction sheet. The HRU replacement procedure is as follows:

- On the enclosure, remove the R-clip and pull the cover slowly off.
- Remove the EPIRB and stow it in a dry place. **It will activate if wet.**
- Hold down the lever arm to take up the force of the spring.
- Push the HRU back then upwards out of the slot in the lever arm.
- When the rear clip disengages slowly release the lever arm.
- The HRU with its breakable rod can now be lifted free and replaced.
- Using pliers, remove the rear E-clip and slide off the old HRU.
- Fit the new HRU over the new rod, with its label facing outward.
- Refit the washer and the rear E-clip. Ensure rod moves freely.
- Mark the HRU with an expiry date 2 years into the future.
- Slide the HRU into the slot in the lever arm and push lever arm down.
- Engage rear washer into backplate by pushing back and sliding down.
- Look under the spring and check that the washer is fully engaged.
- Fit the EPIRB as shown in 5.8.2.
- Refit cover by engaging hole over rod and then snapping into place. Check that the cover is correctly fitted.
- Refit R-clip through top of rod.
- On side of cover, remove old HRU expiry date and mark new date.

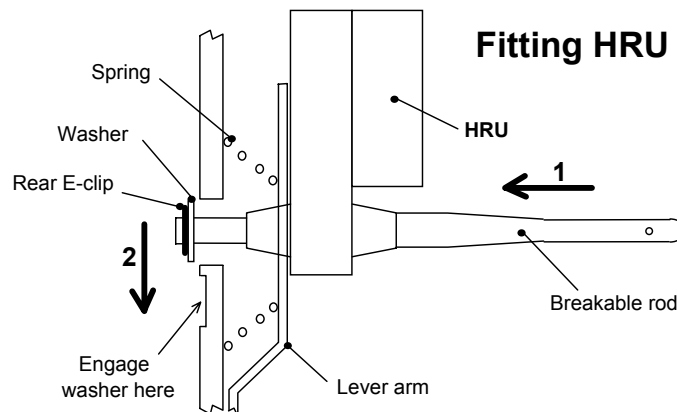

10.4 Battery replacement

The EPIRB uses three 9V Lithium battery packs, McMurdo type 82-939. Typically these will have to be replaced every 5 years. The exact battery expiry date is marked on the rear of the EPIRB lens dome; if you have a full enclosure, it is also marked on the outside of the enclosure. The battery expiry date should be checked regularly. You will need to replace the battery when:

- The expiry date has been reached **or**
- The EPIRB has been used in an emergency situation **or**
- A false activation exceeds 6 hours of use.

REGARDLESS OF THE BATTERY STATE, THE EPRIB SHOULD ALWAYS BE ACTIVATED IN AN EMERGENCY – IT MAY STILL GENERATE AN ALERT.

A battery is a one shot device. It is not rechargeable or user replaceable. Battery replacement **must** be carried out by a McMurdo approved service agent. The entire set of batteries should be replaced together.

NOTE: When the battery is changed, it is the responsibility of the service agent to reset the Long GPS Self Test counter in the Smartfind Plus. For a description of this counter, refer to Section 10.1

Lithium batteries have special disposal requirements. Never incinerate a Lithium battery. Never dispose of one at sea. Your service agent will deal with battery disposal.

10.5 Servicing

All servicing must be carried out by a McMurdo approved service agent. Always call your nearest agent and talk to their service department before returning equipment. You can find your nearest service agent from:

- The McMurdo web site: www.mcmurdo.co.uk
- Contacting McMurdo direct (see warranty page).
- Contacting a McMurdo distributor

If the EPIRB has to be returned, the original packaging should be used if possible.

10.6 Transportation

The battery packs used in these EPIRBs are classified non-hazardous.

For shipping, the battery pack meets exemption A45 of the IATA hazardous transport regulation for categories UN3090 (Lithium batteries), UN3091 (Lithium batteries contained in equipment) and UN3091 (Lithium batteries packed with equipment).

For further information refer to the McMurdo website www.mcmurdo.co.uk

10.7 GMDSS inspections

If your vessel is subject to GMDSS regulations then you can expect to get regular visits from ship surveyors enforcing national legislation. They will check the expiry dates and activate the EPIRB to prove that it really works and they will read the identity message stored inside the EPIRB to check that you have registered it properly. Leisure vessels are not subject to these inspections. However, in some countries passenger and fishing vessels are covered by the legislation.

11 HOW DOES IT WORK?

Your EPIRB contains two radio transmitters: one operating at 406 MHz which transmits an alert which can be received by satellites, and one operating at 121.5 MHz which transmits a signal which can be received by overflying aircraft and Search & Rescue (SAR) homing receivers. When you activate the EPIRB, both transmitters start broadcasting signals. Providing the EPIRB's batteries are in good condition, the transmission will continue for a minimum of 48 hours.

The 406 MHz alert signal can be detected by SAR satellites. American, European and Indian authorities operate a series of satellites in low-earth and geostationary orbits to detect and locate aviators, mariners and land-based users in distress. The satellites, together with a world-wide network of ground stations and Mission Control Centres (MCC) form the International COSPAS-SARSAT Program whose mission is to relay distress signals to the international search and rescue community.

Ground stations track these satellites and process the distress signals to obtain a location (by using Doppler location techniques*) of the distress. The processed information is then forwarded to an MCC where it is combined with other location and registration information and passed to a Rescue Coordination Centre (RCC) which alerts the appropriate SAR authorities. Successive satellite passes refine and confirm this information. Alternatively, beacons such as Smartfind Plus can use the GPS system to obtain a very accurate position. This position is then transmitted as part of the distress signal.

*** For an explanation, visit the webpage:**
<http://www.cospas-sarsat.org/DescriptionOverview/doppler.htm>

The network of orbiting satellites can detect signals over the entire surface of the earth; in addition, there are four geostationary satellites that appear fixed in position and which detect signals over enormous areas (approximately one-third of the surface of the earth, but excluding Polar regions). However, the geostationary satellites, because they are fixed with respect to the earth, cannot determine the position of the EPIRB using Doppler.

The Smartfind Plus EPIRB contains a GPS receiver which can determine its own position. This position is then transmitted as part of the distress signal. GPS reception can be affected by several factors, and GPS systems do require a clear view of the sky in order to work effectively, because the receiver needs signals from several satellites to calculate its position. If the GPS cannot determine its position, it "fails safe"; it does not transmit an inaccurate position, but instead sends information to indicate that no position is available. Position information is then dependent on the orbiting satellite system.



Once it has been activated for a distress situation, an EPIRB should not be switched off until the SAR agency directs this.

12 TECHNICAL SPECIFICATION

406 MHz Transmitter	Operating frequency	406.028 MHz \pm 1 kHz
	Power output	5 W typical
	Modulation	Phase (16K0GID)
121.5 MHz Homer	Operating frequency	121.5 MHz \pm 3.5 kHz
	Power output	50 mW radiated typical
	Modulation	Swept tone AM (3K20A3X)
GPS Receiver (Smartfind Plus only)	Centre frequency	1.57542 GHz
	Sensitivity	-175 dBW minimum
	Satellites tracked	12 max
Strobe light	Type	Two high intensity LEDs
	Light output	0.75 cd minimum
	Flash rate	23 flashes per minute
Battery	Type	Lithium manganese dioxide
	Operating life	48 hours minimum
	Shelf life	5 years typical in service
Environment	Operating temperature	-20 °C to +55 °C (-4° F to +131° F)
	Storage temperature	-30 °C to +70 °C (-22° F to +158° F)
	Automatic release depth	4 metres max. (13 feet)
Physical	Weight	770 grams (1.7 lb)
	Height of body	21 cm (8.2 inches)
	Length of antenna	18 cm (7 inches)
Approvals	Satellite system	Cospas-Sarsat T.001/T.007
	Europe	IEC 61097-2 Marine Equipment Directive
	USA	USCG/FCC approved FCC ID : KLS-XX-X
	Worldwide	IEC 61097-2
	Meets IMO regulations	A.662(16); A.694(17); A.810(19); A.814(19)

This device complies with the GMDSS provisions of part 80 of the FCC rules. The GPS module (where fitted) complies with the relevant sections of IEC 61108-1: 2003.

12.1 Declarations of Conformity

<p>mcMURDO</p> <p>Silver Point Airport Service Road Portsmouth Hampshire UK PO3 5PB Int + 44 (0)23 9262 3900 www.mcmurdo.co.uk</p>	<p>EC DECLARATION OF CONFORMITY</p> <p>We declare that the following products comply with the essential requirements of Council Directive 90/269/EEC concerning the approximation of the laws, regulations, administrative provisions and equipment as amended by Commission Directives 98/84/EC, 2001/45/EC, 2002/75/EC and 2002/84/EC, as evidenced by a EC Type Examination Certificate as detailed overleaf.</p> <p>Products covered by this Declaration Product Type: 408 MHz EPIRB Annex A.1/5.6 Models: McMurdo ES SMARTFIND</p> <p>Intended usage of products All vessels which must comply with IMO SOLAS regulations in coastal or international waters.</p> <p>Surveillance conformity assessment is undertaken in accordance with Production Quality Assurance Module D by: CinetIQ (No. 0191) Cody Technology Park, Ively Road, Farnborough GU14 0LX, United Kingdom</p> <p>The product will carry this Conformity Marking:</p> <div style="text-align: center;">  <p>0191 XX</p> <p>XX = last two digits of year mark affixed</p> </div> <p>Signed:  Name: N. Jordan Title: Engineering Project Manager Date: 10.04.2007</p>
---	--

Page 1 of 2

<p>EC Type Examination Certificate: Name of Notified Body: CinetIQ (No. 0191) Address of Notified Body: Ively Road, Farnborough GU14 0LX, UK Certificate: QQ-MED-1806-01R2 30th March 2007</p> <p>Regulations and Standards complied with: Regulation IV/7.1.6; Regulation X/3; IMO Resolution MSC.38(63) 14.6.1.6 (1994 HSC Code); IMO Resolution MSC.97(73) 14.7.1.6 (2000 HSC Code); IMO Resolution MSC.102(78) (2002) (STCW Code of Practice for the Training of Deck Officers); IMO Resolution MSC.107(74) (2002) (STCW Code of Practice for the Training of Deck Officers); IMO Resolution MSC.120(74) (2002) (STCW Code of Practice for the Training of Deck Officers); IMO Resolution MSC.120(74) (2002) (STCW Code of Practice for the Training of Deck Officers); ITU-R M.633-2(05/00); ITU-R M.695-1(10/95); IMO MSC/Circ.882</p> <p>Testing standards: IEC 60945 (2002); IEC 60945 (2002); IEC 60945 (2002)</p> <p>Technical Construction File held by: McMurdo, a Division of Signature Industries Ltd, Silver Point, Airport Service Road, Portsmouth PO3 5PB UK</p>	<p>ATTENTION The attention of the specifier, purchaser, installer, or user is drawn to special measures and limitations to use which must be observed when the product is taken into service to ensure compliance with the applicable regulatory requirements. Such special measures and limitations to use are available on request, and are also contained in the product owner manuals.</p>
--	---

Page 2 of 2



This Declaration complies with EN ISO/IEC 17050-1:2004

BS EN ISO 9001
Registered in England No. 2820561
Registered in Scotland No. SC53081
Registered in Wales No. 53081
VAT No. GB 028 3127 37

82-889 Iss.3

mcMURDO
Silver Point
Airport Service Road
Portsmouth
Hampshire UK
PO3 5PB
Int + 44 (0)23 9282 3900
www.mcmurdo.co.uk

EC DECLARATION OF CONFORMITY

We declare that the following products comply with the essential requirements of Council Directive 90/269/EEC concerning the minimum requirements for the design of the guarding of machinery as amended by Commission Directive 96/98/EEC, 2001/60/EEC, 2002/97/EEC and 2002/94/EEC, as evidenced by a CE Type Examination Certificate as detailed overleaf.

Products covered by this Declaration

Product Type: 406 Mkx GPS EPRB
Annex A.16.5

Models: **McMurdo G5 SMARTFIND PLUS**

Intended usage of products

All vessels which must comply with IMO SOLAS regulations in coastal or international waters.

Surveillance conformity assessment is undertaken in accordance with Production Quality Assurance Module D by:

QinetiQ (No. 0191)
Cody Technology Park,
Fenny Road,
Portsmouth, GU14 0LX
United Kingdom

The product will carry this Conformity Marking:



XX = last two digits of year mark affixed

Issued on behalf of **McMurdo**, a Division of Signature Industries Ltd.

Signed:

Name: **N. Jordan**
Title: **Engineering Project Manager**

Date: 16.04.2007

See overleaf for technical information

Page 1 of 2

EC Type Examination Certificate:
Name of Notified Body: QinetiQ (No. 0191)
Address of Notified Body: Fenny Road, Farnborough GU14 0LX, UK
Certificate: **00-MED-1706-01R2** 30th March 2007

Regulations and Standards complied with:
Regulation 1.6; Regulation 1.7; IMO Resolution MSC 96(83); ILS 4.6 (1984) HSC Code of Practice 1999; IMO Resolution MSC 97(75); IMO Resolution MSC 98(76); IMO Resolution MSC 99(76); IMO Resolution MSC 100(76); IMO Resolution MSC 101(76); IMO Resolution MSC 102(76); IMO Resolution MSC 103(76); IMO Resolution MSC 104(76); IMO Resolution MSC 105(76); IMO Resolution MSC 106(76); IMO Resolution MSC 107(76); IMO Resolution MSC 108(76); IMO Resolution MSC 109(76); IMO Resolution MSC 110(76); IMO Resolution MSC 111(76); IMO Resolution MSC 112(76); IMO Resolution MSC 113(76); IMO Resolution MSC 114(76); IMO Resolution MSC 115(76); IMO Resolution MSC 116(76); IMO Resolution MSC 117(76); IMO Resolution MSC 118(76); IMO Resolution MSC 119(76); IMO Resolution MSC 120(74); IMO Resolution A.694(17); ITU-R M.633-2(05/00); ITU-R M.690-1(10/95); IMO MSC/Circ 862.

Testing standards:

MSC/Circ 862, MSC/Circ 862
IEC 61097-2 (2002-09); IEC 60945 (2002)

Technical Construction File held by:

McMurdo, a Division of
Signature Industries Limited,
Silver Point, Airport Service Road, Portsmouth PO3 5PB UK

ATTENTION
The attention of the specifier, purchaser, user and installer is drawn to special measures and limitations to use which must be observed when the product is taken into service to maintain compliance with the above directive. Details of these special methods and limitations to use are available on request, and are also contained in the product owner manuals.

This Declaration complies with EN ISO/IEC 17050-1:2004



UKAS EN ISO 9001
Registration No. 2300951
Registered Office: 200, The Quadrant,
London SE20 0BN, United Kingdom
VAT No. GB 626 3127 57

82-281184-3

Page 2 of 2

mcmurdo
 Silver Point
 Airport Service Road
 Portsmouth
 Hampshire
 PO3 5PB
 Int + 44 (0)23 9362 3900
 www.mcmurdo.co.uk

EC DECLARATION OF CONFORMITY

The following products comply with the EU Directive 1999/5/EC (Radio Equipment and Telecommunications Terminal Equipment) and satisfy all the technical regulations applicable. The assessment has been carried out in accordance with Annex IV of the above Directive.

Products covered by this Declaration

Product Type: 406MHz EPIRB
 Models: **McMurdo E5 SMARTFIND**
SIMRAD EP50
SAILOR SE406-II

Intended usage of products

For use in all member States aboard Recreational Craft, Workboats and Non-SOLAS Vessels in coastal/international waters

I certify that the products described above have been tested to the radio suite overleaf and comply with the essential requirements in Articles 3.1(a), 3.1(b), 3.2 and 3.3(e) of the R&TTE Directive.

The product will carry this Conformity Marking:

CE 01910

Issued on behalf of **McMurdo**, a Division of Signature Industries Ltd.

Signed: 

Name: **N. Jordan**
 Title: **Engineering Project Manager**

Date: **10 - 11 - 2007**

See overleaf for technical information

Regulations and Standards complied with:

Regulation IV7.1.6; Regulation X/3; IMO Resolution MSC 36(63) 14.6.1.5 (1994 HSC Code); IMO Resolution MSC 97(73) 14.7.1.5 (2000 HSC Code); IMO Resolution A.694(17); IMO Resolution A.700(17); IMO Resolution A.806(19); IMO Resolution A894(17); ITU-R M.491-1(07/86); ITU-R M.492-6(10/95); ITU-R M.540-2(06/90); ITU-R M.625-3(10/95); ITU-R M.689(06/90)

Testing standards:

MSC/Circ 862;
 IEC 61097-2 (2002-09); IEC 60945 (2002)

Technical Construction File

Notified Body: **QinetiQ - No. 0191**
 Address: **Ively Road, Farnborough GU14 0LX, UK**
 Statement of Opinion: **CE-TEC-07-291**
 Date: **30th March 2007**

If this product is to be incorporated into other appliances or systems then it must not be put into service until the apparatus into which it is incorporated has been declared in conformity with the provisions of the relevant Directives)



BSI BSI 1200 9000
 Registered Office: 100, Brook Road, Tisbury
 Wiltshire, UK
 VAT No: GB 958 3127 57

mcmurdo

Silver Point
Airport Service Road
Porsmouth
Hampshire UK
PO3 5PB
Int + 44 (0)23 5262 3900
www.mcmurdo.co.uk

EC DECLARATION OF CONFORMITY

The following products comply with the EU Directive 1994/EC (Radio Equipment and Telecommunications Terminal Equipment) and satisfy all the technical regulations applicable. The assessment has been carried out in accordance with Annex IV of the above Directive.

Products covered by this Declaration

Product Type: 405MHz EPIRB
Models: **McMurdo G5 SMARTFIND PLUS**
SIMRAD EG50
SAILOR SGE406-II

Intended usage of products

For use in all member States aboard Recreational Craft, Workboats and Non-SOLAS Vessels in coastal/international waters.

I certify that the products described above have been tested to the radio suite overseas and comply with the essential requirements in Articles 3.1(a), 3.1(b), 3.2 and 3.3(e) of the R&TTE Directive.

The product will carry this Conformity Marking:

CE 01910

Issued on behalf of McMurdo, a Division of Signature Industries Ltd.

Signed: 

Name: N. Jordan
Title: Engineering Project Manager
Date: 10-14-2007

See overhead for technical information

Page 1 of 2

Regulations and Standards complied with:

Regulation N/7.1.6; Regulation X/2; IMO Resolution MSC 36(63) 14.6.1.5 (1994 HSC Code); IMO Resolution MSC 37(73) 14.7.1.5 (2000 HSC Code); IMO Resolution MSC 47(46) 14.8.1.5 (2002 HSC Code); IMO Resolution A/894(17); ITU-R M.491(107786); ITU-R M.492(10995); ITU-R M.540-2(06500); ITU-R M.525-2(10959); ITU-R M.688(06590)

Testing standards:

MSC/Circ 82;
IEC 61871-2 (2002-09); IEC 60945 (2002)

Technical Construction File

Notified Body:
Address: Ivelly Road, Farnborough GU14 6LX, UK
Statement of Opinion: QQ-RTTE-0407-01
Date: 30th March 2007

If this product is to be incorporated into other appliances or systems then it must not be put into service until the apparatus into which it is incorporated has been declared in conformity with the provisions of the relevant Directive(s)



BS EN ISO 9001
Registered Office: 1700 Road, Thundersport
Luton, Bedfordshire, LU2 9JH
VAT No: GB 025 3127 27

02-083 Iss.3

Page 2 of 2

13 APPENDIX – SATELLITE SYSTEMS

COSPAS-SARSAT satellite system

The COSPAS-SARSAT system provides distress alert and location information to search and rescue authorities anywhere in the world for maritime, aviation and terrestrial users in distress.

There are two satellite arrays carrying the COSPAS-SARSAT system. The principal array is LEOSAR (Low Earth Orbit Search and Rescue) which has seven satellites in polar and near-polar orbits. The orbits of these satellites are arranged to scan the entire surface of the Earth; on average, a satellite comes into view every 45 minutes.

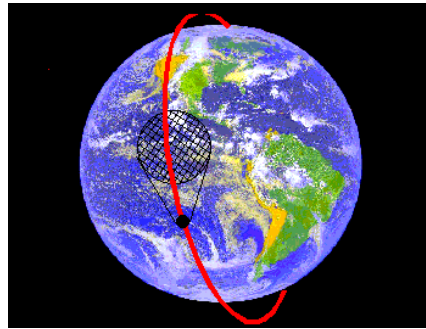

LEOSAR satellite path and scan footprint

Distress transmissions from EPIRBs are picked up by the satellites and retransmitted to ground receiving stations, which then pass the message to the appropriate rescue organisation. On average, the total delay from activation of an EPIRB to the message being received by the rescue services is 90 minutes.

COSPAS-SARSAT is in an advanced stage of commissioning the second satellite array, GEOSAR (Geostationary Search and Rescue). This array uses geostationary satellites which are always in view (over their area of coverage), so that reception of the EPIRB signal is virtually instantaneous



GEOSAR coverage

Global Positioning System (GPS)

The GPS system is a satellite array which enables a receiver located anywhere on Earth to determine its position with high accuracy.

The array uses 24 satellites (plus spares) orbiting the Earth in six orbital planes, four satellites per plane, as shown below. These are arranged so that at least five satellites are within range of any receiver (which can be anywhere) at all times.

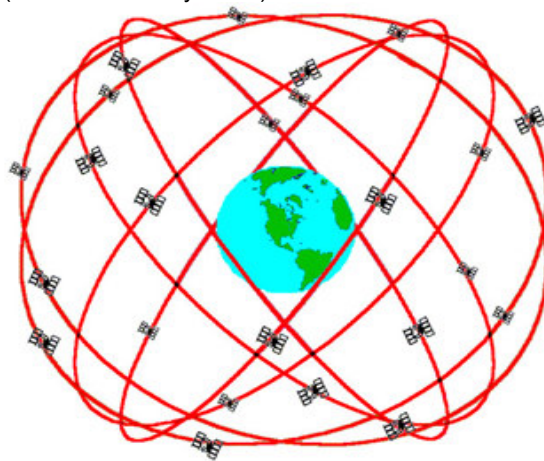

GPS satellite orbital planes

Each satellite transmits information which enables its position and distance from the receiver to be calculated. By combining these data for multiple satellites, the position of the receiver can be calculated.

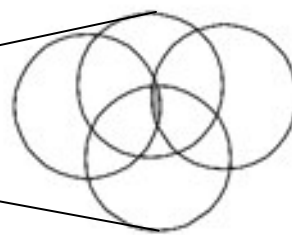
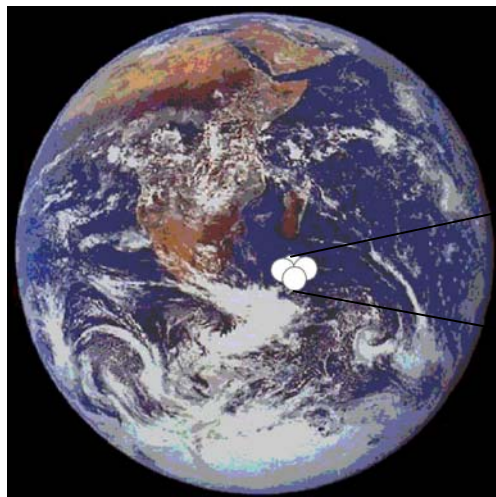

*Operation of GPS receiver
(size exaggerated for clarity)*

14 UNITED STATES EPIRB REGISTRY SYSTEM

Important information

Beacon registration is now available on-line. This is the preferred method of registration; point your browser to <http://www.beaconregistration.noaa.gov> and follow the instructions on-screen.

Use the EPIRB form.

Other Information

At present, NOAA still accepts registration by mail or fax. The registration forms are pre-printed with the correct mailing address and fax number. A registration form may be downloaded from the website given above.

However you register the beacon, you will be sent a decal which must be attached to the beacon.

Emergency Contact

It is VITAL that the Emergency Contact information is accurate, particularly regarding the telephone number, as this will be used to validate an alert. Only if the beacon registration and approximate location details can be confirmed will USCG (United States Coast Guard) launch an immediate rescue, otherwise there will be a delay whilst further alerts from the same source are received and verified.

Registration address:

NOAA SARSAT Beacon Registration
E/SP3, RM 3320, FB-4
5200 Auth Road
Suitland MD 20746-4304

FAX: 301-568-8649

Helpline: 301-457-5678 or toll-free: 1-888-212-SAVE (7283).

15 PRODUCT WARRANTY

McMurdo is a brand operated by Signature Industries Limited. Subject to the provisions set out below McMurdo warrants that this product will be free of defects in materials and workmanship for a period of 24 months from the date of purchase.

McMurdo will not be liable to the buyer under the above warranty:-

- for any defect arising from fair wear and tear, wilful damage, negligence, abnormal working conditions, failure to follow McMurdo's instructions (whether oral or in writing) including a failure to install properly and/or to use batteries recommended and/or supplied by McMurdo, misuse or alterations or repair of the product by persons other than McMurdo or an Approved Service Agent;
- for parts, materials or equipment not manufactured by McMurdo in respect of which the buyer shall only be entitled to the benefit of any warranty or guarantee given by the manufacturer to McMurdo;
- for the battery storage life which is specifically excluded from this warranty;
- if the total price for the product has not been paid.

THE LIMITED WARRANTY STATED ABOVE IS EXCLUSIVE AND IN LIEU OF ANY OTHER WARRANTY, EXPRESS OR IMPLIED, INCLUDING BUT NOT LIMITED TO ANY IMPLIED WARRANTY OF MERCHANTABILITY OR FITNESS FOR A PARTICULAR PURPOSE.

McMurdo will not be liable for indirect, special, incidental or consequential damages of any kind sustained from any cause. In no event shall McMurdo be liable for any breach of warranty or other claim in an amount exceeding the purchase price of the EPIRB. This warranty does not affect any statutory rights of the consumer.

In order to be valid, claims must be made under the above warranty in writing as soon as practicable after discovery of the defect or failure and within the warranty period referred to above. Proof of purchase will be required. The claim should be sent together with the product in question to the address set out below or to an Approved Service Agent.

Following a valid warranty claim McMurdo shall be entitled to repair or replace the product (or part) in question free of charge, or at McMurdo's sole discretion to refund to the buyer the price of the product (or a proportional part of the price). McMurdo shall not be liable to a buyer who is not a consumer for any other loss or damage (whether indirect, special or consequential loss of profit or otherwise) costs, expenses or other claims for compensation which arise out of or in connection with this product. In the case of a consumer McMurdo shall only be liable where other loss or damage is foreseeable.

Nothing shall limit McMurdo's liability for death or personal injury caused by its negligence.

This warranty is to be interpreted under English law.

All enquiries relating to this warranty or Approved Service Agents should be sent to:

McMurdo, Silver Point, Airport Service Road, Portsmouth, Hampshire, PO3 5PB UK
Telephone: Int + 44 (0) 23 9262 3900 Fax: Int + 44 (0) 23 9262 3998
Web: www.mcmurdo.co.uk Email: customerservice@mcmurdo.co.uk

16 END OF LIFE STATEMENT

At the end of the EPIRB's useful life, it is vital that the battery be disconnected from the main unit to prevent false alarms. False alarms cause expensive disruption to Search and Rescue services and may endanger lives as a consequence. It is also necessary that the EPIRB and its battery pack be disposed of in a manner that does not present a threat of environmental damage.

Battery Removal

To disconnect the battery, turn the EPIRB over and remove the three retaining screws using a cross headed screwdriver. Separate the clear dome from the main body of the EPIRB. The circuit board will lift away with the clear dome; if possible avoid touching the PCB. Using fingers; unplug the three white battery connectors and cover the individual white battery connectors with sticky tape to prevent inadvertent short-circuiting. Using a cross headed screwdriver remove the two retaining screws that hold the battery assembly in place. The battery assembly can now be removed from the main body of the EPIRB.

Disposal

The Waste Electrical and Electronic Equipment (WEEE) Directive aims to minimise any adverse impact of electronic equipment on the environment, both during the product lifetime and when it becomes waste. Within the European Union this legislation is mandated by Directive 2002/96/EC, and there is similar legislation in most other continents. The directive applies to all electronic products such as IT, household appliances, portable electronics etc., and imposes requirements to collect, treat, recover and recycle each product at its end of life. Electronic end-user products must also carry a WEEE label (as below) and recovery and recycling information has to be provided to the recycler.



This EPIRB product contains traces of lithium in the battery pack. In addition it may contain lead and brominated flame retardants (BFRs), both in the housing material and circuit boards.

In keeping with the directive, McMurdo strongly recommends that this EPIRB product and its battery pack be disposed of in a sensible and considerate manner. For example, do not simply discard the product in the domestic waste. Instead take it to a civil recycling facility, or contact McMurdo for advice.

McMurdo

A Division of Signature Industries Ltd.
Silver Point
Airport Service Road
Portsmouth PO3 5PB
United Kingdom

Phone: +44 (0)23 9262 3900

Fax: +44 (0)23 9262 3998

Email: customerservice@mcmurdo.co.uk

Website: www.mcmurdo.co.uk

82-810-001 Issue 3